

# DECEMBER 2006

## Merry Christmas

### COMING EVENTS

- |         |   |               |
|---------|---|---------------|
| Dec. 2  | Library Christmas Open House/Santa/Coffee | 9 a.m. - Noon |
| Dec. 4  | Fire Dept. Meeting                        | 7 p.m.        |
| Dec. 5  | Senior Dinner                             | Noon          |
| Dec. 12 | Garden Club                               |               |
| Dec. 16 | Boys & Girls 4-H                          |               |
| Dec. 19 | Senior Dinner                             | Noon          |
|         | City Council Meeting                      | 7 p.m.        |
| Dec. 25 | MERRY CHRISTMAS                           |               |



*Merry Christmas from the Staff*

*Andis*

*Dolores*

*Evelyn*

*Pat*

## City of Fertile

### City Council Special Meeting Minutes Sewer Revenue Loan Public Hearing October, 3 2006, 7:00 PM, City Hall

- 1.) **Call to Order**  
The Fertile City Council met at 7:00 PM in special session, October, 3 2006, at Fertile City Hall.
- 2.) **Roll Call**  
Present were: Mayor Joyce Russell, Council Members: Melanne Bang, Jeff Berg, Gail Shropshire, Patrick Renchin, and Tad Miller, and City Clerk Eddie May.
- 3.) **Public Hearing**  
Mayor Russell opened the public hearing at 7:06 p.m. on the SRF (Sewer Revenue Fund) Loan and Disbursement Agreement. Miller asked how the cash-flow would be affected by an additional loan. May stated he would prepare a cash-flow projection for the next Council meeting. No other comments for or against the proposed loan were presented. Mayor Russell closed the hearing at 7:17 p.m.
- 4.) **Resolution**  
*Renchin moved and Miller 2<sup>nd</sup>, roll call vote was unanimous, to pass resolution 06-03-10: authorizing and approving a Sewer Revenue Loan and Disbursement Agreement and providing for the issuance and securing the payment of \$200,000 Sewer Revenue Bonds.*
- 5.) **Tentative Start Date Set**  
The project start date was set for Monday, October 9, 2006.
- 6.) **Tree Replacement**  
Resident Dan Lee petitioned the City Council to fulfill their prior commitment to replace a tree which was fell during the bridge construction. The City Council authorized the purchase and installation of a replacement tree.
- 7.) **Adjourn**  
*Miller moved, Bang 2<sup>nd</sup> to adjourn.* Meeting adjourned.

## City of Fertile

### City Council Meeting Minutes October, 17 2006, 7:00 PM, City Hall

- 1.) **Call to Order**  
The Fertile City Council met at 7:00 PM in regular session, October 17, 2006, at Fertile City Hall.
- 2.) **Roll Call**  
Present were: Mayor Joyce Russell, Council Members: Melanne Bang, Gail Shropshire, Patrick Renchin, and Tad Miller, City Clerk Eddie May and City Maintenance Manager Warren Bruns. Absent: Council Member Jeff Berg.
- 3.) **Minutes Approval**  
Correction is needed in regards to the last paragraph of the City Clerk's Report. It was printed that the Senior Citizens committee signed a CD over to the City for the Community Center Project. It should have stated that the Fertile Community Center Board signed over a CD to the City of Fertile.  
*Renchin moved and Miller 2<sup>nd</sup> to approve the September minutes with this correction. Motion Carried.*
- 4.) **Library Trustee Renewals**  
Dawn Millard and Karen Usher have renewed their terms as Library Trustees.
- 5.) **I/I Reduction Project**  
**Update on Progress**
  - Construction began today, October 17th.
  - Blue flags and ground paint will be used for locating construction areas. Please leave the flags and paint as they appear.**Approval of Project Expenditures**
  - *Miller moved and Renchin 2<sup>nd</sup>, to approve project expenditures.* Motion Carried.
- 6.) **Discussion of a new utility fee structure**

- May presented a cash flow projection for the sewer system, including the new sewer loan payments. It appears that the current rates will cover the additional payment requirements.
- Discussion continued for the water system and the landfill/recycling services. Projections show a break-even operational cash-flow for water, with no cash-flow for maintenance including the scheduled water tower painting. Projections show a net loss for the landfill/recycling cash flow.
- It was suggested that the garbage fees be raised from \$11 to \$11.50 and the recycling fees be raised from \$1.75 to \$2.25. It was also suggested that the minimum water fee of \$14.50 be maintained while the excess usage over the minimum 2000 gallons be raised from \$.0015 per gallon to \$.0035 per gallon.
- Public hearings will be held at the next two Council meetings to finalize the rates. All citizens who would like input into the rate structure are encouraged to attend. Written statements may be submitted to City Hall as well.

#### 7.) **Mayor's Report**

- Vandals have damaged a porta-potie in the park.
- Curb stops are being located and marked. Broken curb stops will be fixed during the sewer construction project. Costs of repairs are the homeowner's responsibility. Written notices have, or will be sent to the residents with broken curb stops.
- The water tower has been repaired. It was damaged in the electrical storms in August.
- The Library was also hit with lightning. The copier, computers, furnace and air conditioning unit were damaged. Insurance is paying for the repair costs above the deductible.
- The City has received two bids for floor covering for the new handicap accessible restroom in City Hall. The Council has asked for two additional bids to reflect the cost of new flooring for all of City Hall.
- City Council Member Melanne Bang submitted her resignation. The Council will appoint her replacement. Melanne had 1 year left on her term. Citizens who would like to be considered for appointment are requested to attend November's scheduled Council Meeting.

#### 8.) **City Clerk's Report**

- May presented the September financials
- May suggested the implementation of a GIS – Geographic Information System to compile and computerize the information gathered over the last few years in regards to the Sewer, Water, Electrical and Gas lines throughout the City. Miller asked for an estimated length of time for development and the costs associated with development. May suggested using a simplified version of GIS to curb cost and to ensure usability for non GIS personnel. May will research time requirements and costs.
- There were several utility payments that were returned to the City in September. The charge for NSF checks will be raised from \$7.00 to \$30.00 to recover costs associated with administrating NSF checks.
- USDA is continuing to request that the City refinance the current debt on the water and sewer systems. A representative from the City's bank has been contacted to begin the application process.

#### 9.) **City Maintenance Report**

- The snow plow/sander is being prepped for the season.
- Bruns knows of a party who is interested in purchasing the current plow/sander. The City has budgeted enough to purchase a newer plow/sander this fiscal year. The Council asked Bruns to begin to look for a replacement.
- A seal on the sewage lagoon pump is going out. The cost of repairs will be approximately \$2000. The City also has a spare pump that is incompatible with our current system. It could be sold for an estimated \$1,000. The City has a compatible replacement for that spare which will cost approximately \$2500 to repair.

#### 10.) **Approve General Expenditures**

*Renchin moved, Shropshire 2<sup>nd</sup> to approve the expenditures.* Motion carried.

#### 11.) **Other Business**

- The FB&I Committee has enough money left from the anniversary celebration to install welcome banners on the new light poles on

main street and to purchase new Christmas decorations. They also will leave a portion in savings to prepare for future events.

- The FB&I Committee has requested that the City form a committee for the future Community Center.
- The FB&I Committee will be remodeling the current concession stand at the ball fields. They will knock out the existing equipment closets in order to expand the concessions area. They will also build larger equipment closets off the west side of the stands. They have written 3 grants in order to fund this project.

**12.) Next Meeting's Business Topics**

- 1st of 2 public hearings regarding utility rates
- Appointment of a Council Member to fill Bang's seat
- Mill/Dam Repairs and Maintenance

**13.) Upcoming Meetings**

- The Fertile City Council will meet at 7:00 PM in regular session, November 21<sup>st</sup>, 2006, at Fertile City Hall.

**14.) Adjourn**

*Renchin moved, Miller 2<sup>nd</sup> to adjourn. Meeting adjourned.*

**City of Fertile  
Expenditures and Revenues  
As of September 30, 2006**

Type	Name	Paid Amount
<b>General Fund Checking</b>		
Bill Pmt -Check	Ace Hardware	-8.54
Bill Pmt -Check	Alliant Energy	-1,011.93
Bill Pmt -Check	Aquila	-56.68
Bill Pmt -Check	Bruns, Warren V	-62.74
Bill Pmt -Check	Crescent Moon, LLC	-120
Bill Pmt -Check	Farmers Lumber Company	-206.28
Bill Pmt -Check	LGI	-19.6
Bill Pmt -Check	Petty Cash	-48
Bill Pmt -Check	Russell, Joyce V	-29.99
Bill Pmt -Check	Staples	-38.21
Bill Pmt -Check	UPS	-30.67
Bill Pmt -Check	WCTA	-119.61
Bill Pmt -Check	Aquila	-65.04
Bill Pmt -Check	CarQuest	-170.81
Bill Pmt -Check	Crescent Moon, LLC	-120
Bill Pmt -Check	Five Star CO-OP	-4.39
Bill Pmt -Check	Hawkins, Inc.	-5
Bill Pmt -Check	Menards	-41.54
Bill Pmt -Check	North Iowa Media Group	-52.25
Bill Pmt -Check	Pronto	-167.1
Bill Pmt -Check	Russell, Joyce V	-16.01
Bill Pmt -Check	Thompson's Garage	-88.95
Bill Pmt -Check	UPS	-13.07
Bill Pmt -Check	Waste Management	-1,905.96
Bill Pmt -Check	Cherry Tree Builders V	-6,200.00
Bill Pmt -Check	Clapper Tree Service	-7,830.00
Bill Pmt -Check	Bruns, Warren V	-25.81
Bill Pmt -Check	Ace Hardware	-40.03
Check	US Post Office	-111
Check	Hoelt, Faye	-73.93
Check	Rachut, Ron & Becky	-132.06
Check	Anderson, Mark & Christine	-250.38
Check	Lorenz, Sandra	-202
Deposit		2,200.25
Deposit		4,359.45
Deposit		11,139.66
Deposit	Treasurer - Worth County	2,419.62
Deposit		3,358.49
Deposit	Diamond Joe Casino	2,403.91
Deposit		20.94
Liability Check	IRS	-1,684.90
Liability Check	Treasurer - State of Iowa	-182
Liability Check	IPERS	-1,045.82
Paycheck	Bruns, Warren	-1,069.92
Paycheck	Ganz, Dennis	-53.07
Paycheck	Low, David	-300.73
Paycheck	May III, Edgar F	-590.36
Paycheck	Russell, Grant	-735.93
<b>Total General Fund Checking</b>		<b>972.01</b>
<b>Roads Revenue Fund Savings</b>		
Deposit		60.55
<b>Total Roads Revenue Fund Savings</b>		<b>60.55</b>
<b>Water Revenue Fund Checking</b>		
Deposit		2.58
<b>Total Water Revenue Fund Checking</b>		<b>2.58</b>
<b>Sewage Revenue Fund Checking</b>		
Deposit		3.82
<b>Total Sewage Revenue Fund Checking</b>		<b>3.82</b>
<b>TOTAL</b>		<b>1,038.96</b>

**BURTNESS~LUNDGREN  
PLUMBING & HEATING, Inc**

Call for all your Plumbing, Heating,  
& Air Conditioning Needs!

John Burtness & Todd Lundgren 

Clear Lake 357-8882 or Fertile 641-797-2680

**FERTILE LUTHERAN CHURCH (ELCA)**  
602 West Washington  
David Halverson, Lay Minister  
Worship 9:30 a.m.  
Sunday School 10:35 a.m.  
Wednesday Sunday School 6 to 7 p.m.  
Only Jesus, the Living Water,  
can satisfy the thirsty soul.

**FERTILE CHURCH OF CHRIST**  
GLORIFYING GOD BY MAKING DISCIPLES  
- MORE AND BETTER DISCIPLES.

9:00 - SUNDAY SCHOOL FOR ALL AGES.  
10:00 - FELLOWSHIP TIME.  
10:15 - WORSHIP SERVICE.

COME AND BE OUR GUEST.  
3493 EAGLE AVENUE - FERTILE, IOWA



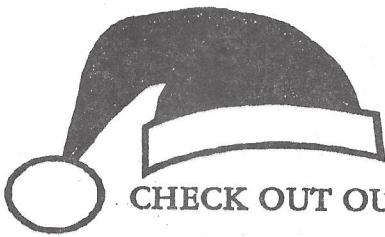

CHECK OUT OUR  
NEW HOURS  
& DAY!

# Merry Christmas

## FERTILE PUBLIC LIBRARY

204 West Main/ Box 198  
Fertile, IA 50434  
(641)-797-2787 Phone/Fax  
Monday & Wednesday - 1:00 - 6:00 P.M.  
Thursday - 3 - 6 P.M.  
Friday - 9:00 A.M. - Noon & 2:00 - 6:00 P.M.  
Saturday - 9:00 am - Noon



**NOW AVAILABLE!**  
Get your Fertile cookbook, potholder, and mitt  
gift wrapped in a holiday basket for only \$26.50.  
Contact the Library to order.  
**A GREAT GIFT IDEA!**

### NEW BOOKS

Motor Mouth - Janet Evanovich  
Strange Candy - Laurell K Hamilton  
A Merry Heart - Wanda E. Brunstetter  
Looking for a Miracle - Wanda E. Brunstetter  
Stripped - Brian Freeman  
All Mortal Flesh - Julia Spencer-Fleming  
Skeleton Coast - Clive Cussler  
Echo Park - Michael Connelly  
Dear John - Nicholas Sparks  
The Memory Keeper's Daughter - Kim Edwards  
Dance of the Gods - Nora Roberts  
Valley of Silence - Nora Roberts  
H.R.H. - Danielle Steel  
Maisie Dobbs - Jacqueline Winspear  
Family - Karen Kingsbury  
Deadly Gamble - Linda Lael Miller  
Thanksgiving - Janet Evanovich  
Blood Valley - William W. Johnstone  
Pride of Eagles - William W. Johnstone  
Deadwood Gulch - Ralph Compton  
Christmas Angel - Thomas Kinkade  
Cold as Ice - Anne Stuart  
Saint - Ted Dekker  
Finding Noel - Richard Paul Evans  
The Innocent Man - John Grisham  
The Historian - Elizabeth Kostova  
Gunsmoke/Dodge the Devil - Joseph A. West  
Collected Short Stories of Louis L'Amour Vol. 4  
Betty Crocker Christmas Cookbook  
Ultimate Christmas Book - Reader's Digest  
The Last Sin Eater - Francine Rivers  
A Clearing in the Wild - Jane Kirkpatrick  
**Large Print-**  
The Brethren - Beverly Lewis  
A Town Called Ruby Prairie - Annette Smith  
Pieces of the Heart - Karen White  
Whispers of Winter - Tracie Peterson

### DVD's

United 93  
Broken Trail - Robert Duvall  
Hoot - Luke Wilson  
The Sentinel - Kiefer Sutherland  
Felicity / An American Girl Adventure  
Oliver Twist - Ben Kingsley  
The Lake House - Keanu Reeves  
Inside Man - Denzel Washington  
Click - Adam Sandler  
Take the Lead - Antonio Banderas

### Audio Books

Collected Short Stories of Louis L'Amour Vol. 4  
Saint - Ted Dekker  
Echo Park - Michael Connelly  
Stripped - Brian Freeman  
Fever - Sean Rowe  
Short Straw - Stuart Woods  
Dark Harbor - Stuart Woods

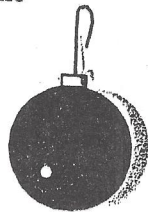
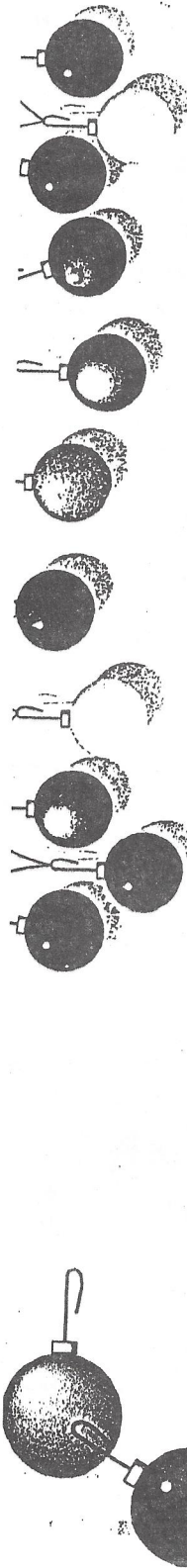

## HERE COMES SANTA!

*Fertile Public Library*

*Christmas Open House*

*Saturday December 2, 2006*

*9 - Noon*

*Santa at 10:00*

*(for ages 10 & under)*

*Raffle Drawing at 11:00*

*(for \$100.00 Wal-Mart Gift Card)*

*Please stop by for Coffee,  
Christmas Punch,  
and lots of Holiday Gummies!*

*Everyone Welcome!*

*Sponsored by Fertile Library Friends*

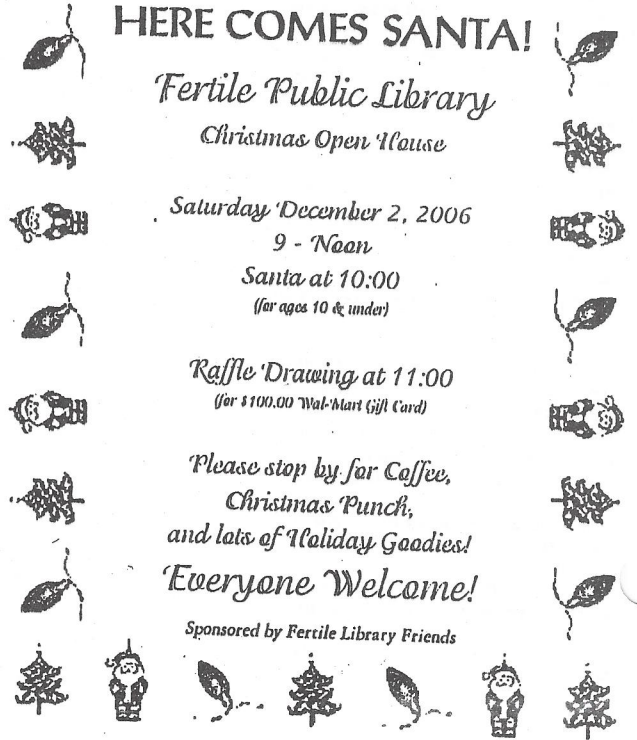

## Last Chance!

That's right - this may be your last chance to buy a copy of the Fertile Memory Book!

There are only a handful of the books available in town. The publisher printed 36 extra copies of the Fertile Memory Book and we are taking orders while supplies last.

Hurry so we can take delivery before Christmas!

### Fertile Memory Book

Mail Order To: Fertile Memory Book  
Elin Miner  
414 348<sup>th</sup> ST  
Fertile, IA 50434

Just \$30.00 @

Order your hard cover, full-color book "Celebrating Our Hometown" over the past 150 years... NOW!

Name \_\_\_\_\_

Address \_\_\_\_\_

City \_\_\_\_\_ State \_\_\_\_\_

Phone \_\_\_\_\_ Zip \_\_\_\_\_

Order Me \_\_\_\_\_ Fertile Memory Books

I have enclosed payment of \$ \_\_\_\_\_

Payment Must Accompany Order.

I will pick up my book.

I have enclosed an additional \$5.00 for shipping and handling - (this will cover up to two books.)

Make payment to Fertile Beautification & Improvement (FB&I)  
Books are due to arrive by 7/31/06

## Movie Starring Fertile!

The Fertile Beautification & Improvement Committee (FB&I) is developing a DVD highlighting the Fertile Sesquicentennial with the help of Rick Anderson. We are looking for video footage of the 150<sup>th</sup> Celebration on either DVD or VHS format.

Rick will use excerpts from the footage submitted along with slides to create the DVD. There will also be a few excellent surprises on it! The DVD will be available some time mid 2007 for a "Donation" to the FB&I that will help fund future projects.

If you are willing to share your video footage, please drop off or mail a copy to the Fertile Library at PO Box 198.

Final day for submissions is January 15, 2007.

Be sure to watch for postings around town for early "Viewings" of a segment that Rick has already completed!

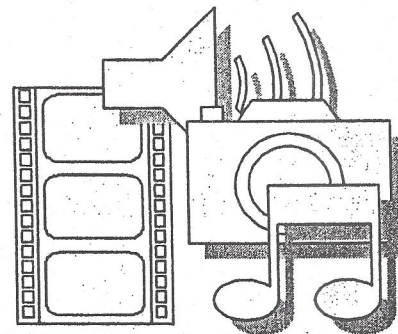

# Bolan Schoolhouse

Antiques, Artwork, Unique Gifts



Thursday, Friday, Saturday  
9:00 AM - 5:00 PM  
(or by appointment)



"Farmers Market" every Thurs, 4:30 - 6:00 PM, thru Oct. 12

"Winneshiek Wildberry Winery" FREE Winetasting 2-5 PM Aug. 26

"Bolan Fall Market" Sept. 23

"Pumpkin Decorating & Hay Rides" Oct. 21

"Country Shops Holiday Tour" Nov. 4

"Christmas Open House" Dec. 9

Lori Willert, Proprietor, 4211 Tulip Lane, Kensett, IA 50448  
641-845-2677 or llwillert@wctatel.net

Bring your automotive needs to us

641-423-1237

641-797-2704



**MILLER'S DIESEL AND  
AUTOMOTIVE, INC.**

3 Commercial Park Road, Mason City, IA  
(8 blocks South of Bonanza)

# First Postoffice in Fertile

## Mail Service Was Begun by W. Rhodes

By MRS. C. E. EIKENBARY  
Globe-Gazette Correspondent

**FERTILE**—The history of the Fertile Postoffice has been brought to light by old newspaper clippings and from talking to old residents who can recall many of the postmasters.

William Rhodes, founder of Fertile, came here from Rosco, Ill., on Aug. 6, 1856, stopping in Mason City, which was a small town at that time. He came on to Fer-



**RHODES O. OUVERSON**  
—Founder —1st

tile and settled down by himself in the wilderness, but soon other men began to arrive and build log cabins, too.

Rhodes and his neighbors walked to Mason City, a distance of 14 miles, for their groceries and mail.

### Rock Postoffice

In 1861, Rhodes named a postoffice which was established on the old Dan Watts farm which was previously the old farm home of Gabriel Pence, who later became Rhodes' father-in-law. He christened the place the Rock Postoffice and Pence was the first postmaster.

Rhodes and Pence were not commissioned postmasters, but they were permitted to keep mail in their homes until the neighbors could call for it. The mail at this



**A. GROVE PHILLIPS**  
—2nd —3rd



**MRS. C. E. EIKENBARY**  
—Present Postmistress

time was carried from Mason City to Bristol and Rock was served on this route. Pence served in this capacity during the Civil War.

People of Fertile at this time paid \$1 a week to get their mail every Saturday. Efforts were being made to get an office established here, but with no success.

### Was Ignored

About the year 1868, Rhodes was traveling on a train when the postal clerk on the train began to electioneer him to support his old comrade, H. O. Pratt, for re-election to Congress. Rhodes emphatically opposed the election of the candidate. He said he would do all in his power to defeat him.

Rhodes said he had asked Pratt again and again for postal service and he had been ignored.



**H. OUVERSON WINTER**  
—4th —5th

A week later citizens in Fertile received notice that a postoffice would be established at once with William Rhodes as postmaster, but this did not develop.

After a while the weekly distribution of mail was dropped. In 1872, a caravan of Norwegians from Mount Horeb, Wis., arrived and among them was Ole Uverson, Fertile's first postmaster. He is an uncle of the present post-

master, Mrs. C. E. Eikenbary. After establishing a general store in the west side of town, arrangements were made with the government to establish a postoffice in Fertile and Ouverson was appointed and commissioned from Washington, D.C. Business must have been slow, for he sold 81 cents worth of stamps. The families the postoffice served were few, but many came long distances for their mail.

### Another Ouverson

Ouverson had charge of the postoffice until 1875, when he was elected clerk of the Worth County court. He sold his store to A. A. Grove and William Kirk. Grove became the second postmaster and continued in that capacity until 1892. During these years, the receipts ranged from \$96 to \$150

a year, showing a small but steady increase.

Dr. N. W. Phillips succeeded Grove and during 1892 and 1893 the receipts doubled.

During the last administration of Grover Cleveland, Halvor Uverson received the appointment as postmaster and the office was operated by his daughter, Olena Elthion, as acting postmaster from 1894 to 1898 with a continuous gain in postal receipts.

Next in line came Will Winter, who accepted the office in May, 1898. He was assisted by Miss



**P. GROVE KIRK**  
—6th —7th

Jessie Brown, later Mrs. J. E. Vincent, now Mrs. Orin Winters.

In 1898 the postoffice was turned over to Peter Grove, who served in that capacity one year, when he resigned to accept the first rural mail route out of Hanlontown after the Chicago Northwestern Railroad was completed through that town.

James Kirk was appointed to fill this vacancy and served for six years when he and his family left for South Dakota with several other families to accept government land. Oscar Rholl succeeded him.

### Stage Coach

In 1914, Charles E. Eikenbary, a former teacher accepted the postmastership and served for 30 years, the longest of any previous



**RHOLL EIKENBARY**  
—8th —9th

postmaster. At the time of his resignation, his wife, Anna, took the civil service examination, received the appointment on Oct. 1, 1944, and is still serving in that capacity.

The story of the Fertile Postoffice would not be complete without telling about the stage coach which served this community for many years. The carrier came once a week, then twice a week and finally every day.

In June, 1902 the government allowed the town two mails a day. The morning mail was brought here from Hanlontown by the rural carrier and in the evening by a mail messenger delivering outgoing mail to the train and bringing mail back.

### Star Routes

Persons living in the 20th century can scarcely appreciate their advantages, but much has changed since William Rhodes walked to Mason City for the mail. Now citizens walk across the street to the postoffice.

The first postoffice fixtures were made by the first postmaster, Ole Uverson, and a desk is still being used by the

present postmaster in sorting the outgoing mail.

All fixtures were owned by the postmaster until 1950 when the government supplied the office with a steel safe, 54 new lock boxes, a sorting table, a filing cabinet, a lobby desk, a sack rack and a rural delivery desk.

There are two star routes serving the Fertile Postoffice. One originates in Mason City and arrives here at 7 a.m. each day and the other originates in Fertile and meets the Mason City star route truck at 7 a.m. The mail is changed from one truck to the other with one going north to Kiester, Minn., and the Mason City one going on to Bancroft. Both trucks return in the evening and exchange mail. That gives the town two outgoing mails each day and two incoming mails each day.

This is a far cry from the stage coach service and the Rock Postoffice.

## WITH SYMPATHY

### WILLIAM WENDALL UPCHURCH

1933 - 2006

William Wendall Upchurch, 72, died October 23, 2006 at his rural home in Colo from complications of a heart ailment.

Funeral services were held October 26th at the United Methodist Church in Colo with Pastor James Roth and Chaplain James Tener officiating.

William (Bill) was born November 25, 1933 near Zearing, Iowa, the son of Clyde and Zelma (Brake) Upchurch. Bill graduated from Fertile High School in 1951. He was united in marriage to Jarlyn Ouverson on June 8, 1952 in Fertile, IA. They moved to Enfield, Illinois and farmed for three years before moving to Colo in 1956. He was a member of the Colo United Methodist Church where he had served on the church board. He was a successful farmer who enjoyed every aspect of farming as well as being a devoted husband and father. Some of his favorite hobbies included fishing, the cattle business and enjoying his grandchildren and great-grandchildren.

He was also a member of the Masonic Columbia Lodge No. 292, A.F. and A.M. and served as Worshipful Master.

Bill is survived by his wife Jarlyn (Ouverson) Upchurch of Colo; three sons and two daughter-in-laws, Perry and Nancy Upchurch and Lindsay Upchurch, all of Colo and Kendall and Sue Upchurch of Zearing; daughter, Julie Upchurch of Coralville, IA; ten grandchildren and, six great-grandchildren. He is also survived by four brothers, Byron Upchurch of the Philippines, Bruce Upchurch of Des Moines, Barry Upchurch of Nevada and Brent Upchurch of Colorado Springs, CO; sister, Betty Arnold of Portland, OR. Bill was preceded in death by his parents and one infant brother, Bradford Upchurch.

Bill will be remembered by his family and friends as being a hard worker and a great family man.

Our deepest sympathy to the family.

### MARGERY IRENE GANZ

1915 - 2006

Margery Irene Ganz, 90, of Rochester, MN died Nov. 10, 2006 at Rochester Healthcare West.

She was born Aug. 11, 1916 at Predmore, MN She graduated from Rochester High School in 1933.

She was married to Fred Ganz on June 16 1935.

Marge is survived by sons Denny (Sharon) of Fertile and Bob of Rochester; daughters, Gwen Riggan of Rochester, Kathy Termeer of Powell, OH and Joyce Krzystofial of Eagan, MN 12 grandchildren and 16 great-grandchildren;

Marge at one time lived in Fertile with Denny and Sharon Ganz.

Our deepest sympathy to the family.

### OUVERSON AND ASSOCIATES

GROUP BENEFITS, LIFE & HEALTH INSURANCE, & LONG TERM CARE

Neil & Betty Ouverson

641-797-2100 Office  
641-797-2101 Fax  
888-944-2127 Toll Free

746A - 342nd St.  
Hanlontown, IA 50444  
ouvers@cs.com

## THANK YOU!

Thank you all for the gifts, money and cards. A special "Thanks" for being at our baby shower.

Laurie Buchanan & Dan Boltz

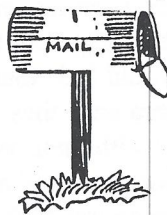

Dear Ladies,

Please renew the Fertile Reminder for another year.

Altho I left "Putsy" after graduating from Fertile High School in 1940, I still have relatives and friends living there.

I enjoy reading the paper and the workers do a great job putting it out there. Thanks a lot!

Helen Suby Sparby  
Iowa City, IA

Dear Ladies,

Please find enclosed payment for my subscription renewal to the Fertile Reminder, plus a gift subscription. Thanks!

Marian Midtgaard

Dear Fertile Reminder,

I have enclosed a check for our renewal of the Reminder. We enjoy receiving it and keeping up with the activities in Fertile now that we no longer have close family living there.

We especially enjoy the good recipes, and have always said that the best cooks around are from Fertile.

Bob & Toby VandenBosch

### FERTILE GARDEN CLUB

The Fertile Garden Club met Nov. 14th, 2006 at Betty Theilen's home. The meeting was called to order with the Pledge of Allegiance. Fourteen members answered roll call to the question "How many years since you graduated High School?"

We then discussed new members to invite and elected our new club officers for 2007.

Diane Schulze gave a lesson on pruning trees and shrubs, and we all signed cards to send to community members we remember at Christmas time.

The meeting was adjourned, and we were served a wonderful lunch by our hostesses Betty Theilen and Pat Lohman.

Diane Schulze, Reporter

### TWEDT FINANCIAL SERVICES, INC

402 West Main, Lake Mills, IA 50450

Joan E. Norem

Home - Auto - Commercial Insurance  
Securities & Investment Services  
Phone 641-692-8200

"We Thank You For Your Business"

## CHILDHOOD ON THE FARM

By George Kisner

### THE RED BICYCLE

In the spring of 1939 when I was 8 years old, a kind neighbor gave me 10 duck eggs. I took them home and with the help of my mother put them under a setting hen to hatch. Hens always had an urge to hide their eggs and raise a family in the spring of the year. They would hide their nest, lay about a dozen eggs and set on them until they hatched. Then they would proudly appear with their brood of chicks. It was no problem, therefore, for us to find an old hen willing to devote her time to hatching my duck eggs. We put her in an old brooder house and I faithfully fed and watered her until the baby ducks appeared. Then she was allowed the freedom of the farm and raised all of her ducklings.

I kept all of the hens and the next February got a drake to go with them. They started to lay and soon I had over 100 duck eggs. You had to take the eggs from them each day or they would quit laying and hatch the eggs. This time I had 8 hens to set the eggs, plus the five duck hens, so I soon became almost overwhelmed by baby ducks. They flourished that summer and I think I had at one time almost 120 half-grown ducklings!

About that time they became restless and started seeking water to swim in. The mother hens pleaded in vain with them to stop their foolishness, but they were determined. Every morning they would march single-file down to the farm pond and every evening they would return quacking loudly for their cracked corn supper. Soon, to my chagrin, I counted fewer and fewer each evening. The foxes and turtles had discovered tasty morsels and were rapidly ruining my duck herd. I finally shut the rest in a wire pen, much to their great indignation, and in the fall I still had about 30 ducks to sell.

I had no trouble selling them by putting a small ad in the local paper and soon possessed the enormous sum of \$12.00. With that money, I purchased a used red bicycle. This was the greatest bicycle I had ever seen. I quickly learned to ride by coasting it down hill and soon was peddling for miles on the gravel roads in the neighborhood. I learned one painful lesson early on. You do not ride with both hands off the handlebars on a gravel road.

The last day of school in Fertile we were allowed to ride bicycles to school and then to the park for the school picnic. I could hardly wait for that day to come and show off my new bicycle to my friends! The great day finally came and when the sun came up I was ready to go. My mother restrained me as long as possible, but I was at the schoolhouse before anyone. My red bicycle was the envy of everyone and it was one of my proudest moments as we all rode to the park with the town people watching!

### DOWNTOWN CAFE

WINTER HOURS  
OPEN FROM 5:30 AM TO 1:30 PM  
TUESDAY NITE 4:30 - 7:30  
TACO OR ALL YOU CAN EAT SOUP  
THURSDAY NITE - FISH, BBQ OR  
CHICKEN - 4:30 - 7:30 P.M.

PHONE 797-2510



### HARE ELECTRIC

FRED, JIM, TOM & ALLEN HARE

PHONE: 1-641-797-2722

101 N. STATE ST.  
FERTILE IA, 50434

PAGER: 1-641-422-3017

TROUBLES OUT OF REACH??  
Call Tom's Electric at 797-2223  
TOM SHEIMO, OWNER

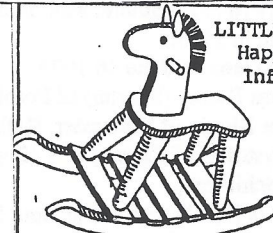
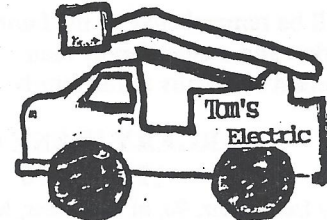

LITTLE TYKES CHILD DAYCARE  
Happy Home Environment  
Infants to School Age  
JOELY BRUNS  
801 W. Main St.  
Fertile, IA  
Phone 797-2699



**Pronto - Fertile**  
Open 7 A.M. - 9 P.M. Mon. - Sat.  
8 A.M. - 8 P.M. Sun.





# COOK'S KORNER

I am in need of recipes. How about you cooks out there helping me out? Send your recipes to: File Reminder, Box 62, Fertile, IA 50434. Thank you to those who have sent recipes.

## CHRISTMAS JEWELS

375°

1 cup oleo                      1/2 cup sugar  
3 hard cooked egg yolks    1 tsp Vanilla  
2 cups flour                    dash of salt

Cream oleo, sugar and vanilla. Add egg yolks—(mashed up), flour and salt. CHILL 1 hour. Shape into balls making a small dent with finger. BAKE 10 minutes. Fill dents with jelly and return to oven for 1 or 2 minutes. Makes 5 dozen. Mint or strawberry jelly is nice for the holidays.

## CHRISTMAS WREATHS

Small round pretzels  
Melt some White Almond Bark  
Fill center of pretzel with Almond Bark and put a small M & M in the center.

\*\*\*\*\*

### (jokes from Ole & Lena's Fortune Cookies)

When Ole's chicken got sick, Lena killed the other to make soup to make it well!

Ole to Sven: "I beat Lena up every morning,"  
"That's terrible" said Sven.  
"Yes, I get up at six and Lena gets up at seven".

Best of all!!!!  
Ole thinks politicians should get two terms—  
One in office and one in Jail!

PERSONAL TOUCH  
BEAUTY SALON  
Tom & Nance Sheimo  
641-797-2422



# FUN KORNER

L	S	T	S	R	A	O	T	K	N	A	M	I	B
E	E	E	O	S	T	L	A	K	C	A	J	S	T
M	N	N	E	S	L	E	R	L	G	C	K	O	
A	U	G	O	C	A	I	H	A	A	O	O	A	V
C	D	G	R	H	H	T	M	M	R	B	S	O	E
J	T	E	A	U	A	O	A	P	S	I	I	R	G
L	O	R	N	R	R	C	I	M	S	E	D	A	E
N	I	J	U	A	A	O	E	U	C	O	Z	U	N
A	O	K	O	T	N	G	T	E	N	E	N	G	A
I	R	S	A	B	S	C	N	A	L	S	I	A	Y
B	D	H	D	N	A	N	I	L	G	B	N	S	B
U	O	R	D	C	E	R	E	U	S	A	N	D	I
N	S	E	A	F	Y	D	M	O	J	A	V	E	L
A	K	W	X	S	Y	E	N	R	A	H	T	E	E

## Desert

Word of 11 letters meaning:  
Sidewinder

- |         |          |          |
|---------|----------|----------|
| ADDAX   | GOBI     | OASIS    |
| AGAVE   | HARNEY   | OCOTILLO |
| ARABIAN | HEAT     | ORDOS    |
| ARID    |          |          |
| ATACAMA | JACKAL   | SAGUARO  |
|         | JOJOBA   | SAHARA   |
| CACTUS  |          | SAND     |
| CAMEL   | KALAHARI | SCORPION |
| CEREUS  | LIBYAN   | SECHURA  |
| DENAKIL | MOJAVE   | SHREW    |
| DUNES   |          | SIMPSON  |
|         |          | SONORAN  |
| FENNEC  |          | STURT    |
|         | NAMIB    | SYRIAN   |
| GAZELLE | NEGEV    | TENGER   |
| GEMSBOK | NUBIAN   | THAR     |
| GIBSON  |          |          |



TEDDY BEAR LEARNING CENTER  
CHRISTIAN DAY CARE  
Betty Waddington & Penny Miller  
Infants to school age...pre-school  
Ph: 896-2445 or 797-2704

LARSEN PLUMBING & HEATING  
641-797-2219



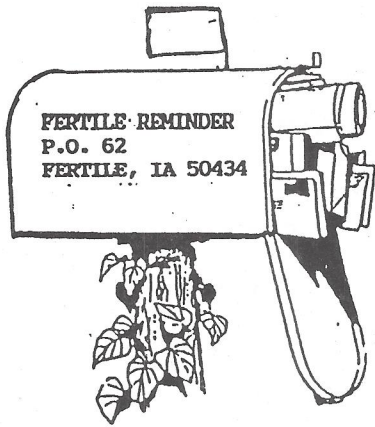

PRSR STD  
US Postage Paid  
Fertile, IA 50434  
Permit No. 3



THE "X" IN THE MAIL BOX REMINDS YOU THAT IT IS TIME TO RENEW YOUR SUBSCRIPTION. A DONATION OF \$6.00 IS SUGGESTED. WE HOPE YOU HAVE ENJOYED "THE REMINDER" THIS PAST YEAR AND WILL WANT TO KEEP IT COMING. YOU MAY SEND YOUR DONATION TO THE ADDRESS IN THE MAIL BOX.

#11/50434\_X  
Library Fertile  
PO Box  
Fertile IA 50434

## NOTICE!!!!!!

Beginning with the new year, we will be changing the deadline date for articles etc. to be included in that month's Reminder. The reason for this is that the City Council changed its council meeting to the third Tuesday of the month. That was resulting in the news being old by the time it got into the next month's Reminder. Our new deadline will be the third Tuesday of each month. We hope this will rectify the situation.

The Reminder Staff

## CHILDHOOD ON THE FARM

This book of 24 original descriptive stories with a personal twist is real memories from the depression days of the 1930s and early 1940s. It is a time of transition from horse power to gas powered tractors. With horse-drawn farm machinery, the only sounds heard were the creak of the harness, the call of the meadowlark and pheasants and the lowing of cows from the pasture. I found over 75 actual photographs taken from personal collections, the Library of Congress Library and the State Historical Library, showing the effects of the depression on family farm life. There are also pictures of myself and my wife Harriet and some of my original poems are added. My book is not always a happy book, but tells it the way we were. All five of us Kisner children graduated from Fertile High School. I enjoy tremendously my occasional trips back to Fertile and if my simple little book could help expand their library, it would give me the greatest pleasure. I ordered 300 copies for the first printing and only hope I will have to re-order until I am penniless. This book is available by sending a donation of not less than \$15.00 plus handling and mailing to Fertile Library, Box 198, Fertile, IA, 50434, or George Kisner, Box 293, Wellman, IA, 52356.

George Kisner

*George does not mention it in the above, but he plans to give the profits from this book to the Fertile Library.*